

H.264 INDOOR DOME NETWORK CAMERA

  
***PixelPro* SERIES**

ZN-D2MTP(-IR) / ZN-D1MTP(-IR)

| **USER'S MANUAL**

Before connecting, operating or adjusting this product,  
read this instruction booklet carefully and completely



# SAFETY INSTRUCTIONS

- 1) Read these instructions.
- 2) Keep these instructions.
- 3) Heed all warnings.
- 4) Follow all instructions.
- 5) Do not use this apparatus near water.
- 6) Clean only with a dry cloth.
- 7) Do not block any of the ventilation openings. Install in accordance with the manufacturer's instructions.
- 8) Do not install near any heat sources such as radiators, heat registers, stoves, or other apparatus that produce heat.
- 9) Only use the attachments/accessories specified by the manufacturer.
- 10) Use only with a cart, stand, tripod or bracket specified by the manufacturer, or sold with the apparatus. When a cart is used, use caution when moving the cart/apparatus combination to avoid injury from tip-over.



- 12) Unplug this apparatus during lightning storms or when unused for long periods of time.
- 13) Refer all servicing to qualified service personnel. Servicing is required when the apparatus has been damaged in any way, such as power supply cord or plug is damaged, liquid has been spilled or objects have fallen into the apparatus, the apparatus has been exposed to rain or moisture, does not operate normally, or has been dropped.

## CALIFORNIA USA ONLY

This Perchlorate warning applies only to primary CR (Manganese Dioxide) Lithium coin cells in the product sold or distributed ONLY in California USA. "Perchlorate Material - special handling may apply, See [www.dtsc.ca.gov/hazardouswaste/perchlorate](http://www.dtsc.ca.gov/hazardouswaste/perchlorate)."

### Caution

Danger of explosion if battery is incorrectly replaced.  
Replace only with the same or equivalent type.

These servicing instructions are for use by qualified service personnel only. To reduce the risk of electric shock does not perform any servicing other than that contained in the operating instructions unless you are qualified to do so.

In USA and Canada, Use Class 2 Power Supply Only

# Contents

<b>1. Product Features .....</b>	<b>5</b>
<b>2. Accessing the Camera.....</b>	<b>9</b>
2.1 Access from a browser.....	9
2.2 Accessing the camera from the Internet.....	10
2.3 Adjusting the Image and Focus .....	10
2.4 The Live View page.....	10
2.5 Video stream types .....	11
2.6 How to stream H.264 .....	11
<b>3. The Setup .....</b>	<b>12</b>
<b>4. Analog output.....</b>	<b>13</b>
4.1 Analog Output Setup .....	13
<b>5. Video .....</b>	<b>13</b>
5.1 Codec.....	13
5.2 Camera .....	16
5.2.1 Exposure Control .....	16
5.2.2 Day & Night Control .....	17
5.2.3 White Balance Control .....	17
5.2.4 Image Property Control.....	17
5.2.5 Lens Adjustment .....	17
<b>6. Audio.....</b>	<b>18</b>
<b>7. Live.....</b>	<b>19</b>
7.1 Setup.....	19
7.2 Privacy Masking .....	20
<b>8. FTP .....</b>	<b>21</b>
8.1 FTP > Config .....	21
8.2 FTP > Event.....	21
8.3 FTP > Periodical.....	22
<b>9. Event.....</b>	<b>23</b>
9.1 Event > Alarm Port.....	23
9.2 Event > Motion.....	24
9.3 Event > Mapping .....	25
<b>10. Network.....</b>	<b>26</b>
10.1 Network > IP Setup .....	26
10.2 Network > Service Port .....	28
10.3 Network > RTP .....	28
10.4 Network > E-mail.....	29
10.5 Network > DDNS.....	29
10.5 Network > UPnP .....	30
<b>11. System .....</b>	<b>31</b>
11.1 System > User.....	31
11.2 System > Date & Time .....	32
11.3 System > Maintenance .....	33
11.4 System > Information .....	35
<b>12. Dimension (mm).....</b>	<b>36</b>

13. Specification ..... 37

# 1. Product Features

The GANZ PixelPro is a high performance H.264 network camera, designed for demanding security installations. It delivers crisp, clear images, disclosing every detail, thanks to its top quality Megapixel progressive CMOS sensor and advanced image processing.

Supported by the industry's largest base of video management software, the GANZ PixelPro provides the perfect solution for securing bank offices, airports and other facilities, and for traffic surveillance, over IP based networks.

The optimal Power over Ethernet (IEEE 802.3af) support power to the camera to be delivered via the network, eliminating the need for a power outlet and reducing installation costs. Steady power could be guaranteed with a central Uninterruptible Power Supply (UPS).



The GANZ PixelPro offers a comprehensive set of network security and management features.

This includes support for port based network control (IEEE802.1X), which allows the camera to be connected to a network secured with this control, and HTTPS encryption, which provides a secure channel between camera and application. It also enables authentication of the video source. Video products are efficiently managed with the powerful Management tool, which is provided on the Installation CD which comes with camera.

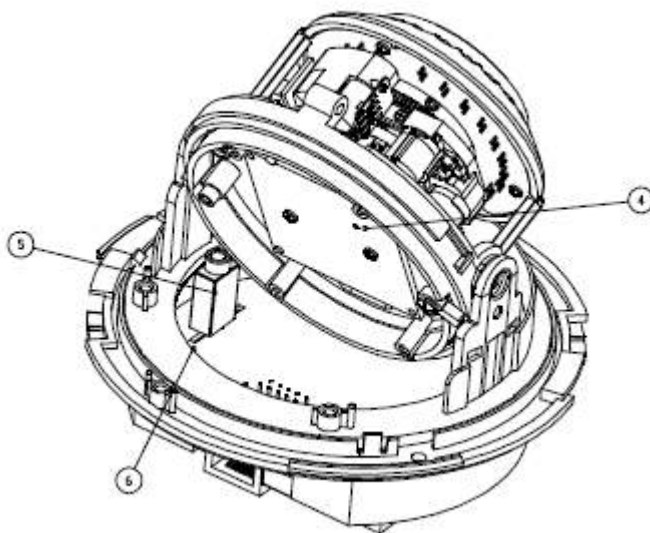
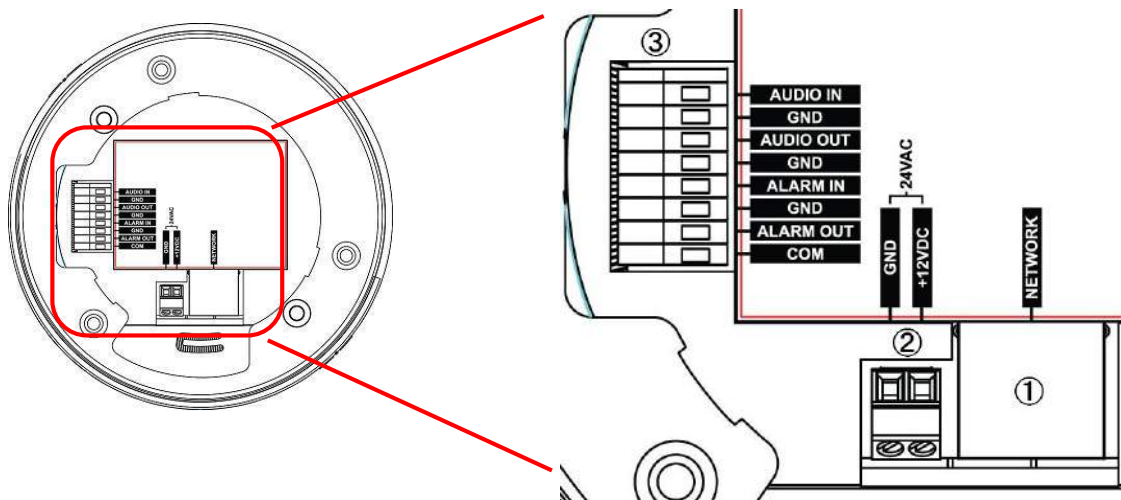

### 1. Network connector (RJ-45 PoE supported)

The GANZ PixelPro connects to the network via a standard network cable, and automatically detects the speed of the local network segment (10BaseT/100BaseTX Ethernet). This socket could also be used to power the GANZ PixelPro via Power over Ethernet (PoE). The camera auto-senses the correct power level when using a PoE switch, router or injector.

### 2. Power connector

12 VDC or 24VAC power connector

### 3. I/O Signal terminal block

#### Audio in

Audio in (line level), for line-in mono signal (only left channel is used from a stereo signal)

### Audio out

The Audio output (line level), which could be connected to a line output of a microphone system or an active speaker with a built-in amplifier.

### Alarm in

One analog (dry contact) alarm input

### Alarm out

One relay output (**0.5A 125VAC / 1A 30VDC**)

## 4. Control Button

This button has 3 functions by pressing time.

- 1) Switch NTSC / PAL format (less than 1 second)
- 2) System reboot (around 5 seconds)
- 3) Factory Default Reset (More than 10 seconds)

## 5. Video output for service monitor

This analog video output is available. Use accessory cable to video output.

## 6. Status LED

<i>LED Color</i>	<i>Indication</i>	<i>System Status</i>
Green	On	Connection to 10/100Mbps Network / LAN. Network connection is established.
	Flashes	Indication of network activity. Camera is booting up.
Unlit	-	No network connection established. When no or incorrect power is supplied.
Amber	On	Camera reset is in progress.
	Flashes	Factory Default settings are in progress.

## Installation Preparation

- 1) Turn the bottom cover clockwise and separate the unit and the cover.
- 2) Separate the top cover and the camera unit.
- 3) Make holes for cables to ceiling / wall with supplied template.

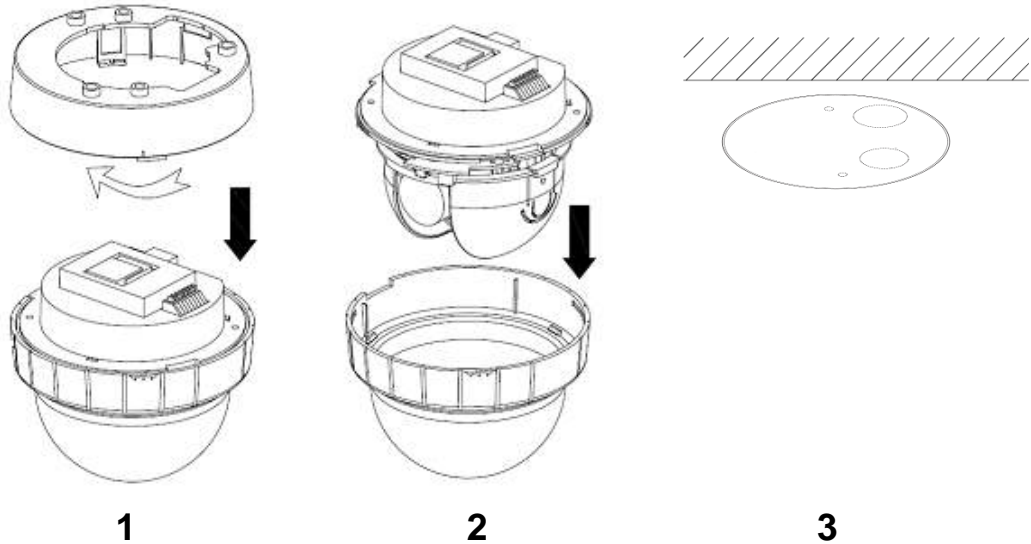

## Mounting to a ceiling / wall

- 4) Secure the bottom cover to a ceiling / wall with two supplied tapping screws (4x30) and anchors.
- 5) Attach the unit to the bottom cover and turn it counter clockwise. Then secure the unit with two supplied tapping screws (3x8).
- 6) Attach the top cover to the unit.

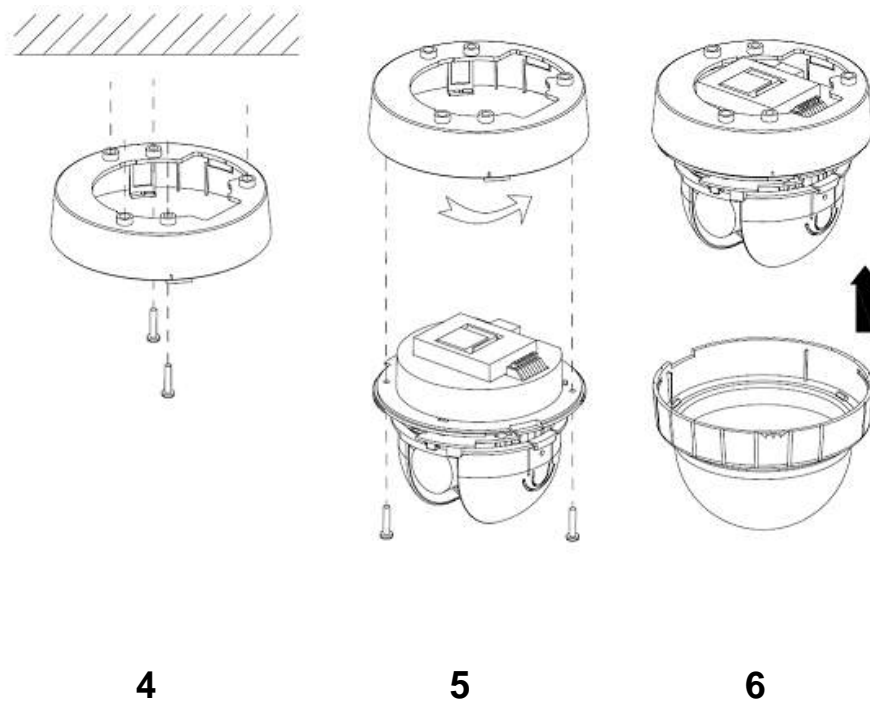



## 2. Accessing the Camera

Follow the instructions in the GANZ PixelPro Installation Guide to install the camera.

The GANZ PixelPro could be accessed with most standard operating systems and browsers. The recommended browser is Internet Explorer for Windows with other operating systems.

### 2.1 Access from a browser

1. Start a browser (Internet Explorer)
2. Enter the IP address or host name of the camera in the Location/Address field of your browser. Press Enter.

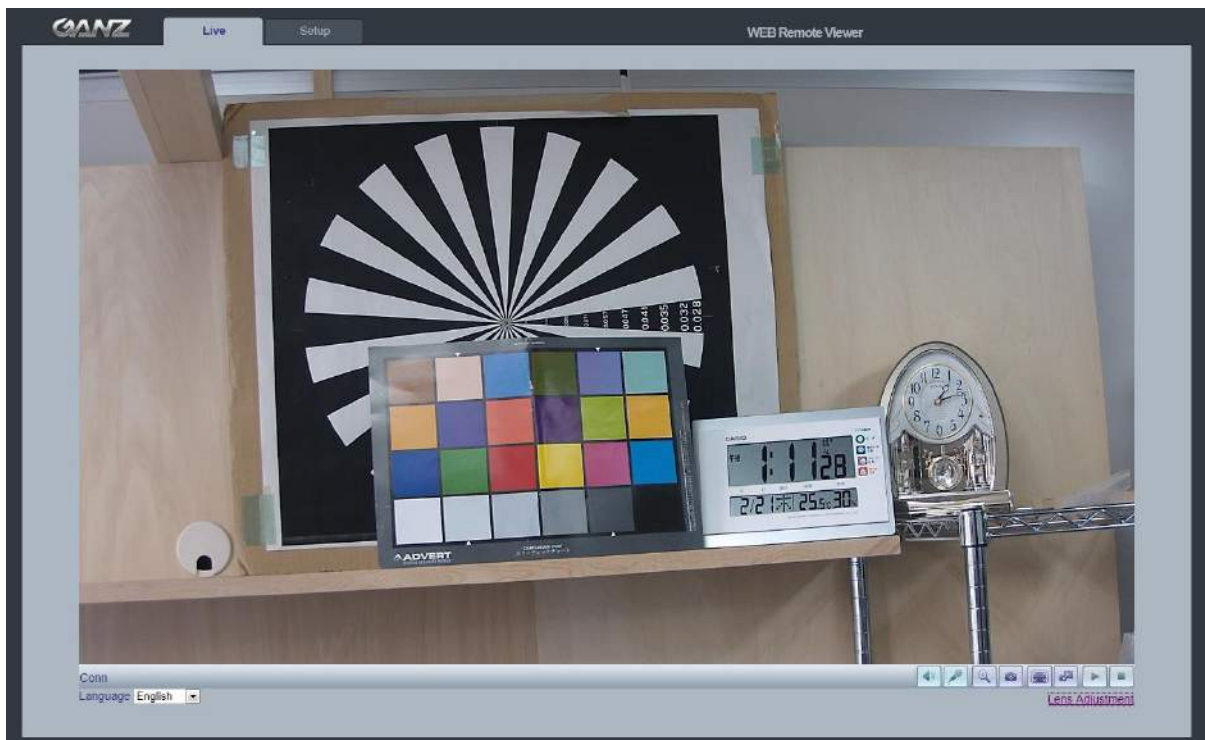

3. Login dialog will appear when the camera is accessed for the first time.
4. The default user name is **ADMIN**, and password is **1234**.
5. The camera's Live View page is now displayed in your browser.

Note: The layout of the live view page in the camera may have been customized to meet specific requirements. Consequently, some of the examples and functions featured here may differ from those displayed on your own Live View page.

## 2.2 Accessing the camera from the Internet









Once installed, the camera is accessible on the local network (LAN). Configure the router/firewall to allow incoming data traffic to access the camera from the Internet. For security reasons this is usually done on a specific port. Please refer to the documentation for router/firewall for further instructions.

## 2.3 Adjusting the Image and Focus

To adjust the position of the lens:

1. Open the **Live View** page in your web browser.
  - Select the **Setup** tab, and open the **Analog output** page.
  - Select the 'Video Format'.
2. Connect analog monitor to the VIDEO OUT (BNC) on the supplied cable.
  - Control the ZOOM/FOCUS by the Lens Adjustment window, and adjust the camera angle.  
For lens adjustment method, please refer to "5.2.5 Lens Adjustment".
3. Check the image from the **Live View** page on your web browser.
4. You can refocus adjustment by Lens Adjustment window, if you want fine lens adjustment.

## 2.4 The Live View page

-  Enable/Disable PC Speaker output
-  Enable/Disable PC Microphone input
-  Digital Zoom
-  Snap Shot
-  Full Screen
-  Video Stream change: First stream ↔ Second stream
-  Play: Click this button by manually to start the stream
-  Stop: Click this button by manually to stop streaming

*NOTE: It is possible that not all the buttons described below will be visible unless the Live View page has been customized to display them.*

## 2.5 Video stream types

### H.264 protocols and communication methods

- **RTP (Real-time Transport Protocol)** is a protocol that allows programs to manage the real-time transmission of multimedia data, via unicast or multicast.
- **RTSP (Real Time Streaming Protocol)** serves as a control protocol, to negotiate the type of transport protocol to use for the stream. RTSP is used by a viewing client to start a unicast session.
- **UDP (User Datagram Protocol)** is a communications protocol that offers limited service for exchanging data in a network which uses the Internet Protocol (IP). UDP is an alternative to the Transmission Control Protocol (TCP). The advantage of UDP is that, it is not required to deliver all data and may drop network packets when there is network congestion. This is suitable for live video, as there is no point in re-transmitting old information that will not be displayed anyway.
- **Unicasting** is communication between a single sender and a single receiver over a network. This means that the video stream goes independently to each user, and each user gets own stream. A benefit of unicasting is, in case one stream fails, it only affects one user.
- **Multicasting (Will be supported)** is bandwidth-conserving technology that reduces bandwidth usage by simultaneously delivering a single stream of information to multiple network recipients. This technology is used primarily on delimited networks (intranets), as each user needs an uninterrupted data flow and should not rely on network routers.

## 2.6 How to stream H.264

Deciding on the combination of protocols and methods to use depends on your viewing requirements, and on the properties of your network. Setting the preferred method(s) is done in webpage.

### **RTP+RTSP**

This method (actually RTP over UDP and RTSP over TCP) should be your first consideration for live video, especially when it is important to always have an up-to-date video stream, even if some images are lost due to network problems. This could be configured as multicast or unicast.

**RTP/RTSP/Multicasting (Will be supported)** provides the most efficient usage of bandwidth, especially when there are large numbers of clients viewing simultaneously. Note however, that a multicast broadcast could not pass a network router unless the router is configured to allow this. For example, It is impossible to multicast over the Internet.

**RTP/RTSP/Unicasting** should be used for video-on-demand broadcasting, so that there is no video traffic on the network until a client connects and requests the stream. However, as more and more unicast clients get connected, the traffic on the network will increase and may cause congestion. Although there is a maximum of 10 unicast viewers, note that all multicast users combined count as 1 unicast viewer.

### RTP/RTSP

This unicast method is RTP tunneled over RTSP. This could be used to exploit the fact that it is relatively simple to configure firewalls to allow RTSP traffic.

## 3. The Setup

The GANZ PixelPro is configured from the Setup link, which is available on the top left hand side in the web interface. This configuration could be done by:

- **Administrators**, who have unrestricted access to all settings under the Setup tab.

Accessing the Setup link from a browser

1. Start your web browser and enter the IP address or host name of the camera into the address bar.
2. The Live View page is now displayed. Click on the Setup tap.

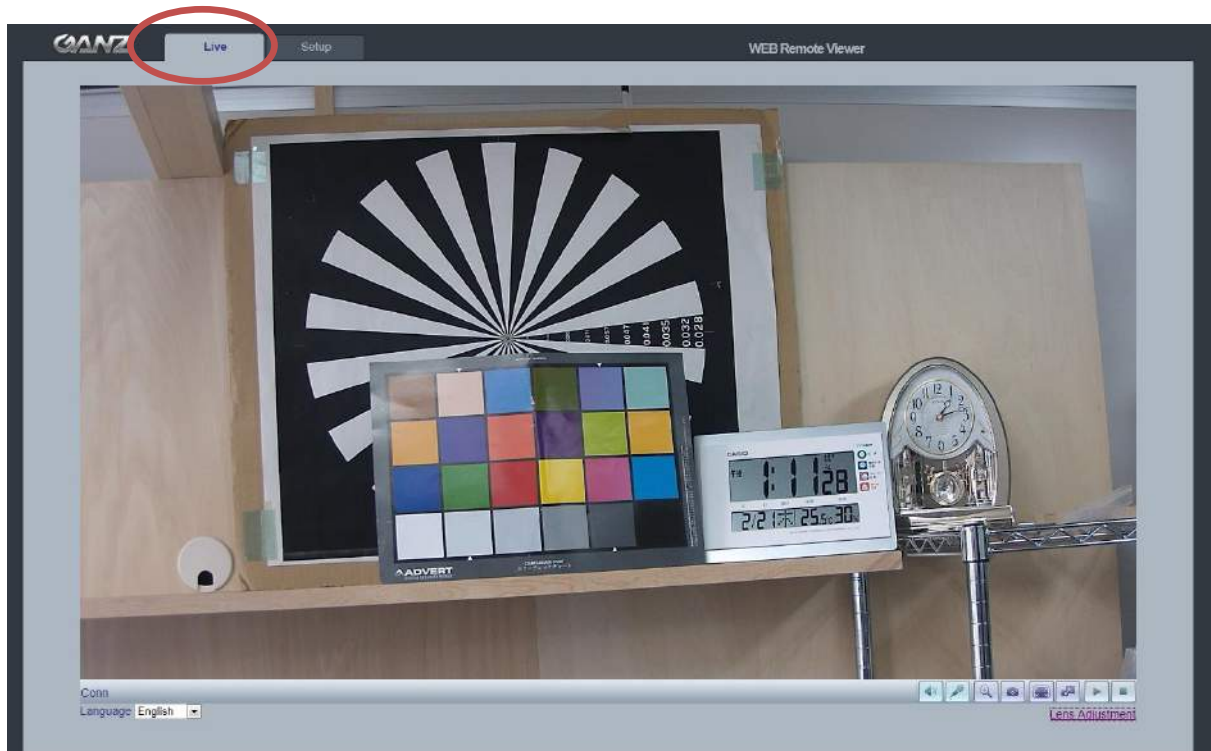

## 4. Analog output

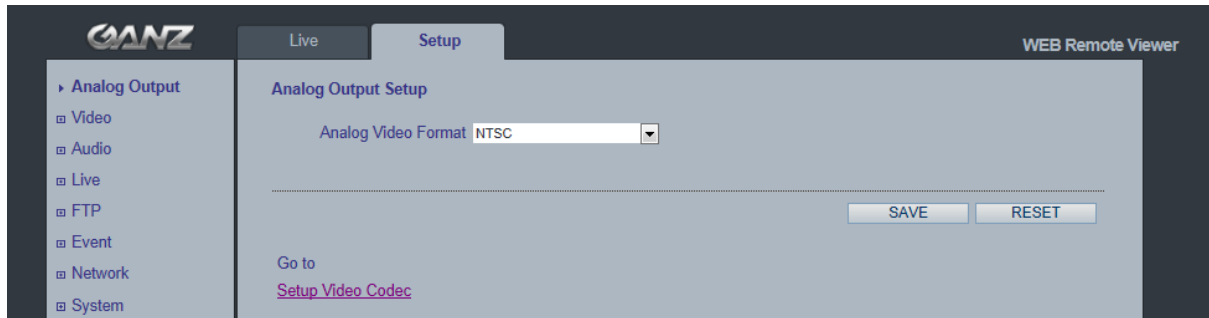

### 4.1 Analog Output Setup

**Analog output** allows selection of output format of the analog BNC output from the camera. NTSC, PAL: Analog Output is selectable.

## 5. Video

The following descriptions show examples of some of the features available in the GANZ PixelPro.

### 5.1 Codec

These are the tools for adjusting the H.264 settings and controlling the video bit rate.

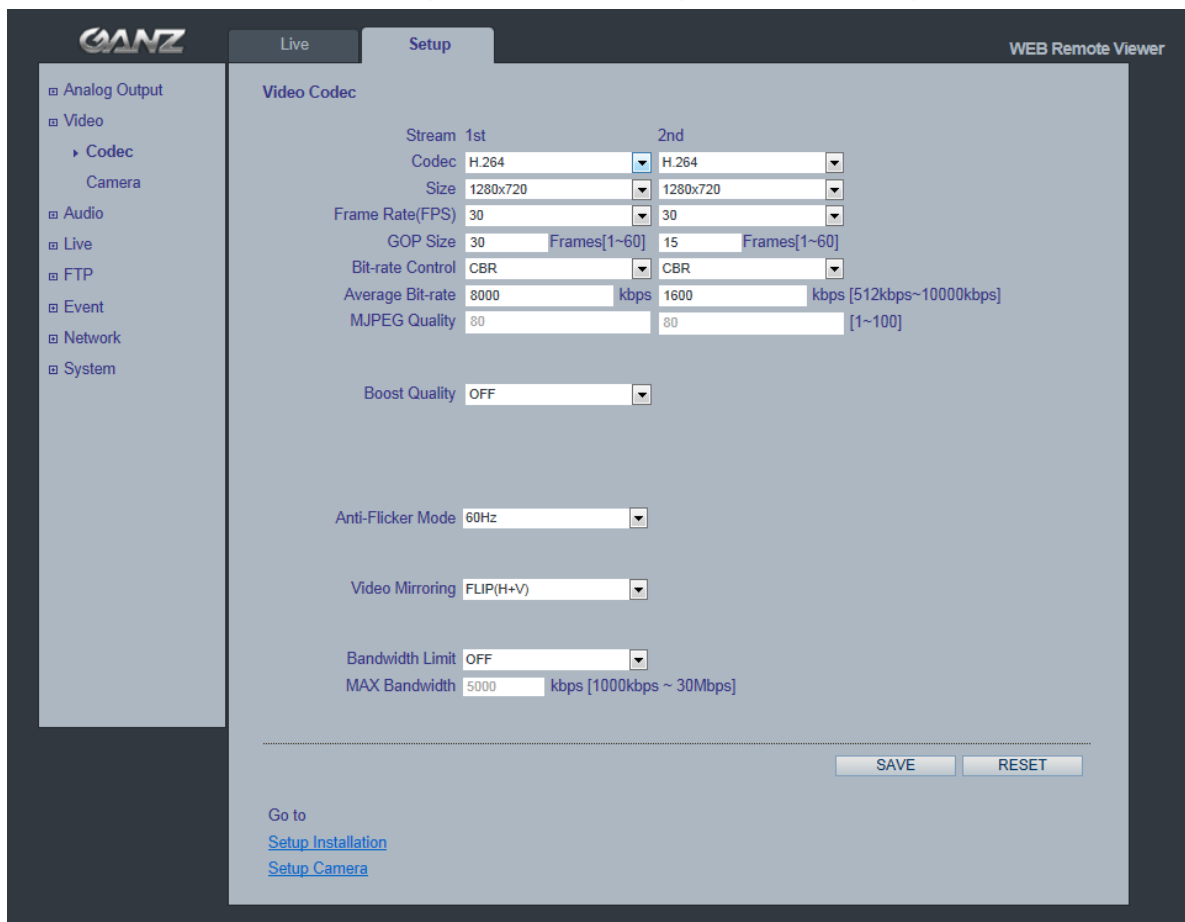

## **H.264**

This is a video compression standard that makes good use of bandwidth and which could provide high-quality video streams at less than 1 Mbit/s.

The H.264 standard provides scope for a large range of different coding tools for use by various applications in different situations, and the GANZ PixelPro provides certain subsets of these tools.

Using H.264, it is also possible to control the bit rate, which in turn allows the amount of bandwidth usage to be controlled. CBR (Constant Bit Rate) is used to achieve a specific bit rate by varying the quality of the H.264 stream. While using VBR (Variable Bit Rate), the quality of the video stream is kept as constant as possible, at the cost of a varying bit rate.

### **Motion JPEG**

This format uses standard JPEG still images in the video stream. These images then are displayed and updated at a rate sufficient to create a stream that shows constantly updated motion.

The Motion JPEG stream uses considerable amounts of bandwidth, but also provides excellent image quality and access to every individual image contained in the stream. Multiple clients accessing Motion JPEG streams could use different image settings.

### **Codec**

H.264 / MJPEG

### **Size**

Video output resolution. See the next page for the output resolution table.

### **Frame rate**

1~30fps in normal mode (1~15fps for slow shutter mode)

*Note: If the slow shutter mode is turned on and the low light condition is met, the frame rate is automatically goes down. In this case, the frame is half of the normal mode.*

### **GOP Size**

1 ~ 60 frames

### **Bit-rate control (CBR or VBR)**

When using H.264 compression, if there is only limited bandwidth available, a constant bit rate(CBR) is recommended, although this may compromise image quality. Use a variable bit rate(VBR) for the best possibly image quality.

### Average Bit-rate (512Kbps ~ 10Mbps)

Recommended bit rate for D1: 800Kbps ~ 1Mbps

Recommended bit rate for 1.3M(720p): 3Mbps ~ 4Mbps

Recommended bit rate for 2.0M(1080p): 6Mbps ~ 8Mbps

### Anti-Flicker mode (Flicker less mode)

60Hz:NTSC

50Hz:PAL or flicker-free mode(to use the camera in locations lit by fluorescent lighting).

### Video Mirroring

Select Video Mirroring mode NONE/ HORIZONTAL / VERTICAL / FLIP(H+V)

### Bandwidth Limit

Limit the bandwidth that the GANZ PixelPro can use during a network connection.

### Max Bandwidth

Specify the maximum bandwidth that the GANZ PixelPro can use during a network connection.

### < Output resolution table for PixelPro >

First Stream	Second Stream							
1920x1080	704x480	640x480	640x360	640x352	352x288	352x240	320x240	-
1280x1024	704x480	640x480	640x360	352x288	352x240	320x240	-	-
1024x768	704x480	640x480	640x360	352x288	352x240	320x240	-	-
1280x720	1280x720 0	704x576	704x480	640x480	640x360	352x288	352x240	320x240
704x576	704x576	640x480	640x360	352x288	-	-	-	-
704x480	704x480	640x480	640x360	352x240	-	-	-	-
640x480	640x480	320x240	-	-	-	-	-	-
640x360	640x360	320x240	-	-	-	-	-	-
352x288	352x288	-	-	-	-	-	-	-
352x240	352x240	-	-	-	-	-	-	-
320x240	320x240	-	-	-	-	-	-	-



## 5.2 Camera

This section allows you to adjust various camera settings.

The screenshot displays the GANZ camera's web interface in 'Setup' mode. On the left is a navigation menu with options like Analog Output, Video, Codec, Camera, Audio, Live, FTP, Event, Network, and System. The main area features a live video feed of a camera view showing a dartboard, a color calibration chart, a digital clock, and a round analog clock. Below the video feed are various control panels: Exposure Control (Exposure Mode: AUTO, AGC Gain: 0 dB, e-Shutter Speed: 200, Slow Shutter: OFF, MAX AGC: LOW, P-Iris Control: AUTO, BLC Control: OFF), White Balance Control (WB Mode: AUTO, MWB Mode: INDOOR (2800K)), Image Property Control (Sharpness: 8, Brightness: 15, Contrast: 15, Color: 15), Day / Night Mode (AUTO, 0 sec), and Anti-Flicker Mode (Go to Anti-Flicker setup). There are also buttons for SAVE and RESET, and a link for Lens Adjustment.

### 5.2.1 Exposure Control

#### Enable AE (Auto Exposure)

ON: Use this setting for automatic exposure control.

OFF: Use these settings to control camera exposure manually.

To compensate for poor lighting conditions, you can adjust the Color level, Brightness, Sharpness, Contrast and Exposure control.

**NOTE:** When AE is enabled, some of the submenus (AGC Gain, e-Shutter Speed) will be disabled.

#### Slow shutter mode

For low light conditions, turn on slow shutter mode.

#### Max AGC Gain

For low light conditions, adjust to a higher value, such as 30dB.



## BLC Control (Back Light Compensation)

The BLC adjusts the exposure of scenes with strong backlight in the center-bottom of the image. When the image background is too bright, or the subject too dark, backlight compensation makes the subject appear clearer. The settings for low light behavior determine how the camera behaves at low light levels. These settings affect video image quality and how much noise is in the images.

### 5.2.2 Day & Night Control

#### Day & Night Mode

**Auto/Day/Night-** If set to Auto, the camera will automatically switch according to the current lighting conditions.

### 5.2.3 White Balance Control

#### WB Mode

ON: ATW (Automatic White balance)

OFF: MWB (Manual White balance)

The White balance adjustment setting is used to make the colors in the image appear consistent, compensating for the different colors present in different light sources.

The GANZ PixelPro camera can be set to automatically identify the light source and compensate for its color temperature. If necessary, the type of light source could be set manually..

### 5.2.4 Image Property Control

Modify the video signal parameters, such as: Brightness, Sharpness, Contrast, and Color.

Sharpness (Default: 8, Range: 1~15)

Brightness (Default: 15, Range: 0~30)

Contrast (Default: 15, Range: 0~30)

Color (Default: 15, Range: 0~30)

### 5.2.5 Lens Adjustment

Adjust the lens (Zoom, Focus & Iris) from this window.

One Push Focus : Camera will automatically adjust the focus.

Default : Back to initial position(wide end).

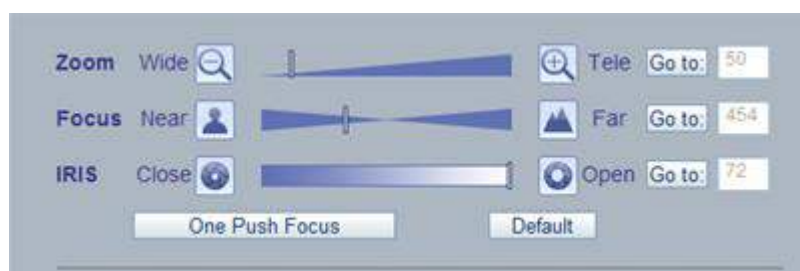

## 6. Audio

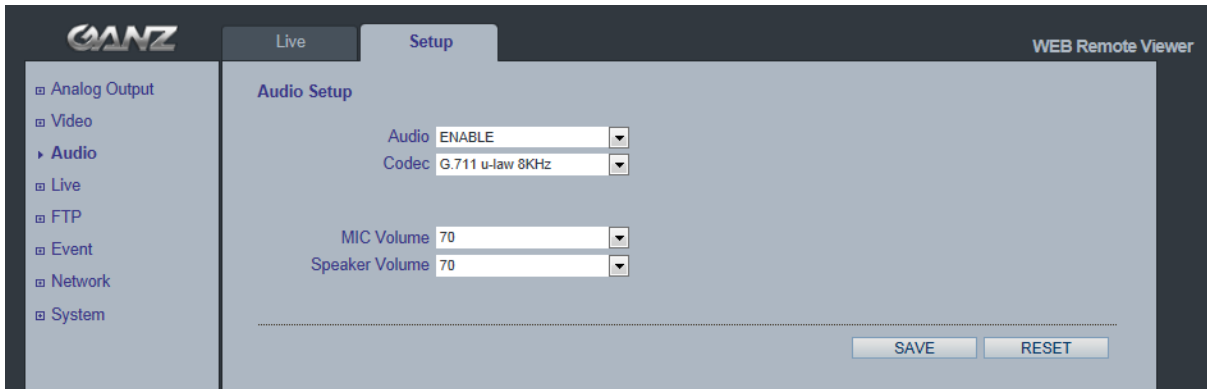

The GANZ PixelPro camera could transmit audio to other clients, using a connected external microphone and could play audio received from other clients via connected speakers. This section describes how to configure the basic audio settings for the GANZ PixelPro camera, such as setting the communication mode, adjusting the sound levels in the microphone and speakers connected to the camera.

**Note:** The speakers connected to the audio output must have a built-in amplifier, such as PC speakers.

### Audio

ON/OFF : Check this to enable audio in the GANZ PixelPro camera.

### Codec

G.711 u-law

### MIC Volume

### Speaker Volume

Adjust the MIC and Speaker Volume.

### Audio Input

Audio from a connected a line source could be connected to the Audio in connector of the GANZ PixelPro camera. If there are problems with the sound input being too low or high, adjust the **input gain** for the microphone connected to the GANZ PixelPro camera.

## 7. Live

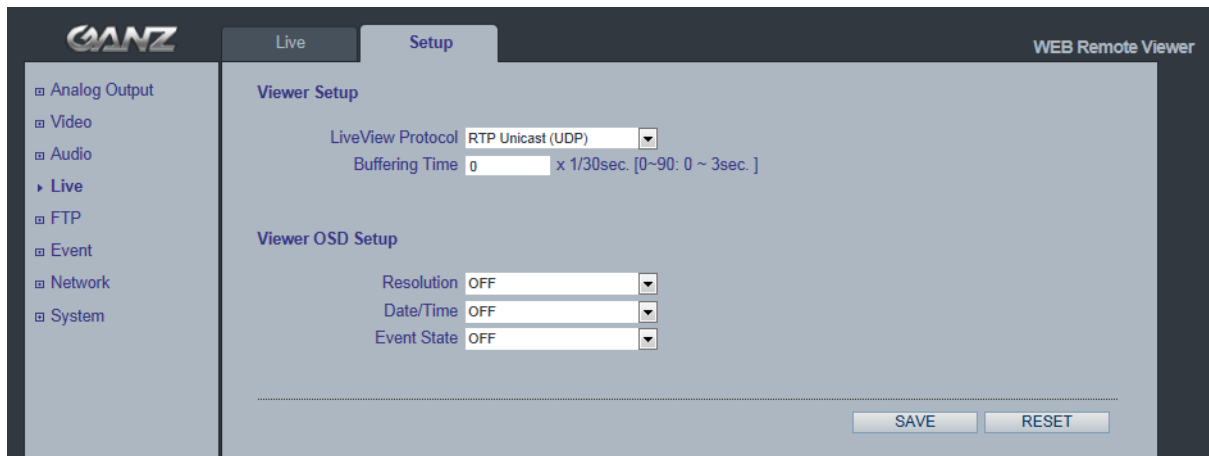

### 7.1 Setup

The GANZ PixelPro could support 10 simultaneous users. In case of multicast, the GANZ PixelPro could support unlimited number of users. If supported on the network, consider using multicasting, as the bandwidth consumption will be much lower.

#### Viewer Setup

LiveView Protocol

RTP Unicast (UDP) / RTP Multicast (UDP) / RTP over RTSP (TCP)

Buffering Time (frame based)

Determines (0 ~ 90) x 1/30 sec (0 ~ 3sec)

#### Viewer OSD Setup

**Date** : Determines whether the date is displayed.

**Resolution** : Determines whether the camera title is displayed.

**Event State** : Determines whether the event state is shown on display window.

## 7.2 Privacy Masking

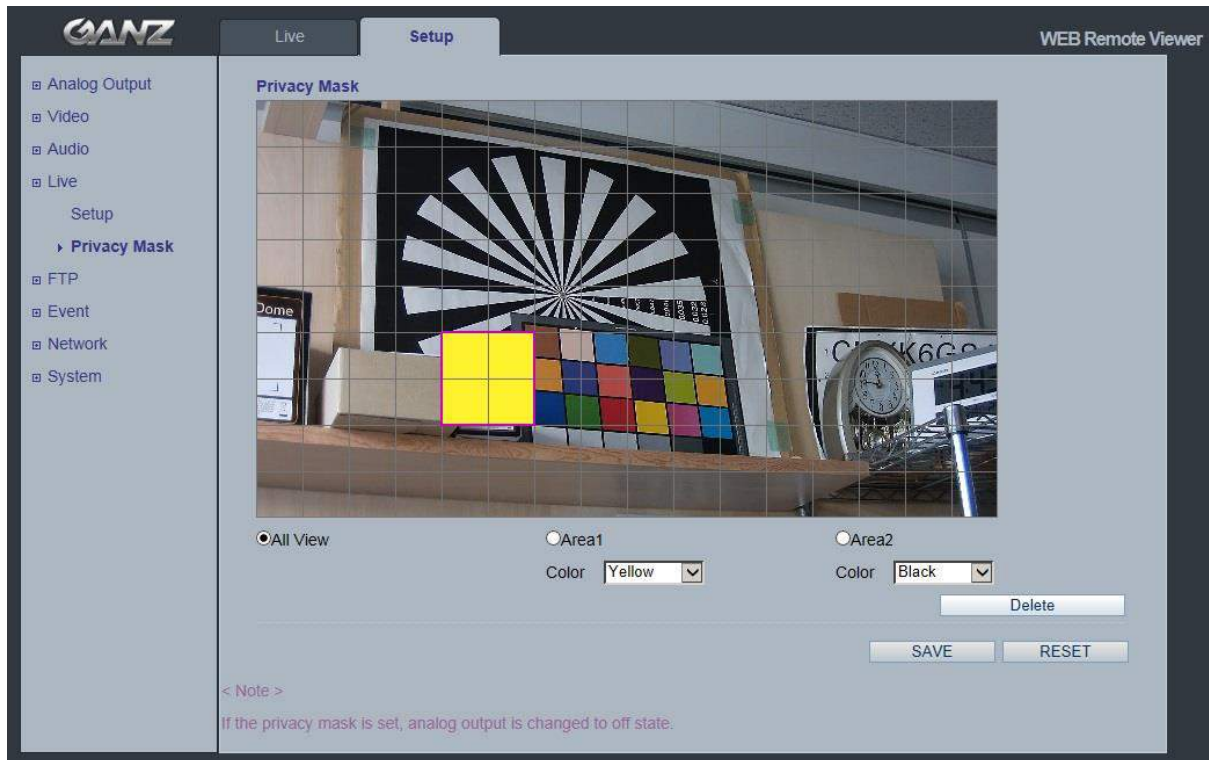

This uses masking to hide sections that you do not want to appear in the shooting screen. A maximum of 2 locations can be set.

### Mask Area

All View : Shows the masking area both Area 1 and 2.

Click the Masking Area 1 or 2 to make a masking.

### Mask color

Sets the mask color

Black, White, Light Gray, Dark Gray, Yellow, Red, Blue, Green

### Mask Creation Procedure

1. Click **Privacy Mask** in the Live menu.
2. Select **Area1** or **2** to activate a setup window.
3. Set the Mask Color in the drop-down list.
4. Click the Masking window, and select an area that you want to specify the masking area.
5. Click **Save**.

Note: When the Privacy Masking is set, analogue output will be changed to off state automatically.

\* Privacy masking is available from FW1227 and later.

## 8. FTP

### 8.1 FTP > Config

The screenshot shows the 'Setup' tab of the GANZ WEB Remote Viewer interface. The left sidebar contains a navigation menu with options: Analog Output, Video, Audio, Live, FTP, Config (selected), Event, Periodical, Event, Network, and System. The main content area is titled 'Server Configuration'. It features a dropdown menu for 'FTP Sverver' set to 'Disable'. Below this is the 'External Server Configuration' section with input fields for 'Server IP' (0.0.0.0), 'Port' (21, with a default range of .21, 1025-65535), 'User name', and 'Password'. A 'Send Mode' dropdown is set to 'Active'. At the bottom right are 'SAVE' and 'RESET' buttons. A 'Go to' link for 'Setup Video Codec' is at the bottom left.

**Server Configuration (This function is N/A on this model)**

#### External Server Configuration

It is setting page to transmit the still shot to remote sites, using the FTP server. Specify the external FTP server information such as IP address, port number, Username and password.

Note :

When the first stream is set to 1920x1080, please set the 2nd stream to MJPEG or H.264 with resolution less than 352x288. If 2nd stream is set to H.264 greater than 640x352, 30fps streaming is not guaranteed due to performance limitation.

### 8.2 FTP > Event

The screenshot shows the 'Setup' tab of the GANZ WEB Remote Viewer interface. The left sidebar contains a navigation menu with options: Analog Output, Video, Audio, Live, FTP, Config, Event (selected), Periodical, Event, Network, and System. The main content area is titled 'Event FTP Sending'. It features a radio button selection for 'FTP Sending' with 'Enable' selected. Below this is a 'Directory' input field (event) and a 'File Prefix' input field (ex) alm\_. There are checkboxes for 'FTP Send Mapping' for 'Alarm In' and 'Motion'. The 'Effective Period' is set to 'Always' with a radio button selection, and a 'Schedule' option is also present with a time selection field (00:00 - 00:00). At the bottom right are 'SAVE' and 'RESET' buttons. A 'Go to' link for 'Setup Video Codec' is at the bottom left.

## Event FTP Sending

It enables FTP transmission triggered by event.

Directory : This folder will be created into external FTP server automatically.

File Prefix : The file name will start from this prefix.

Mapping : You can specify event mapping for Event FTP.

Effective Period : You can specify “Always” or “Schedule”

## 8.3 FTP > Periodical

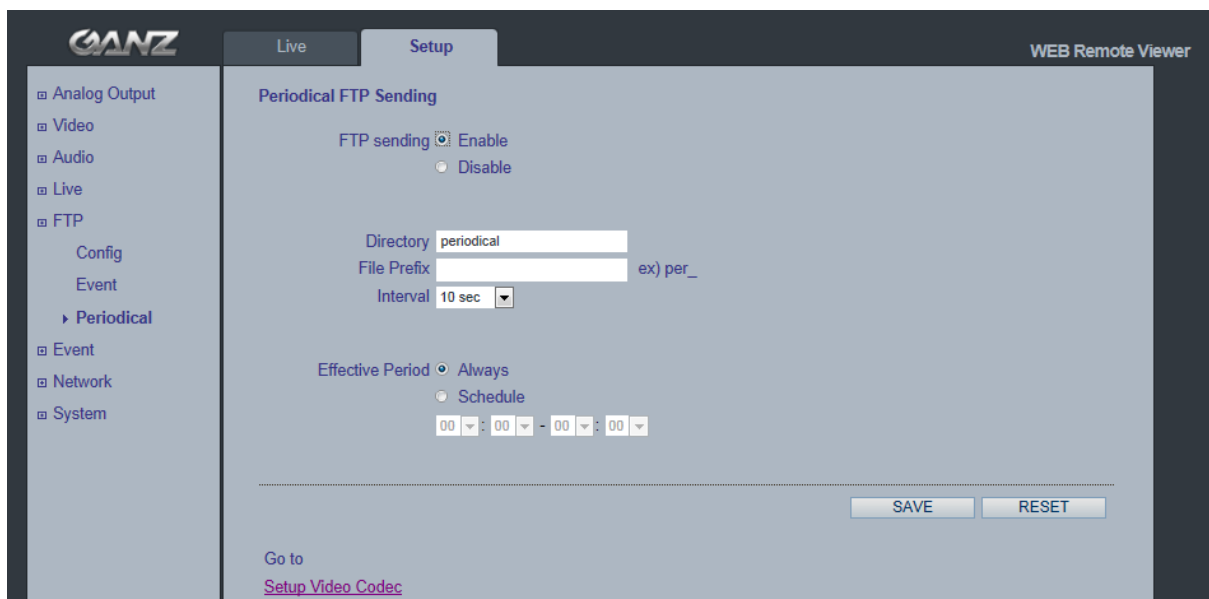

## Periodical FTP Sending

It enables FTP transmission periodically.

Directory : This folder will be created into external FTP server automatically.

File Prefix : The file name will start from this prefix.

Interval : You can specify interval time for uploading to FTP.

Effective Period : You can specify “Always” or “Schedule”

## 9. Event

### 9.1 Event > Alarm Port

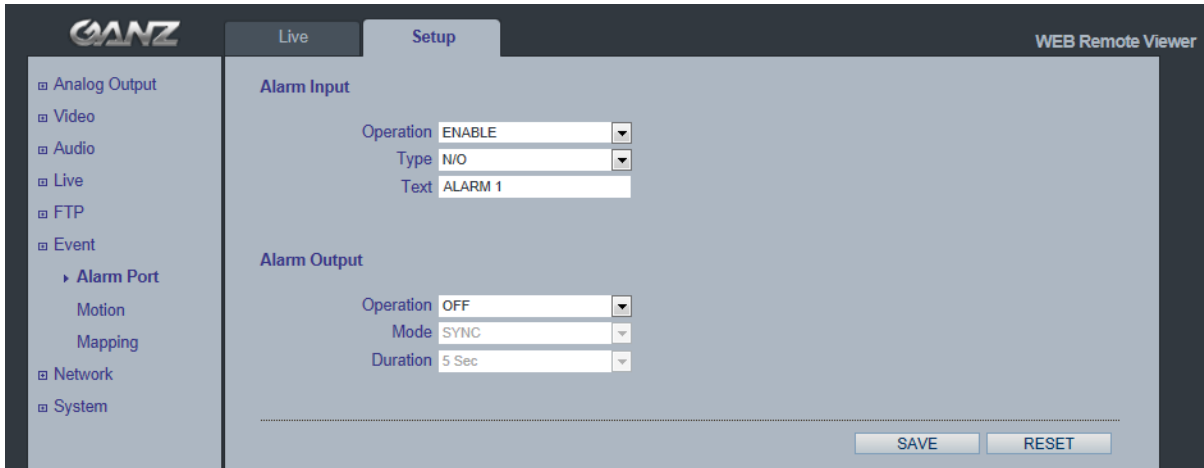

**Alarm Input** - Used for connecting external alarm devices and triggering images for specific alarm-based events. The input is typically connected to a motion detector or any other external security device, and images could be uploaded whenever the detector is activated. **Maximum 5VDC** is allowed on the input.

**Output** - This could drive a maximum load of **0.5A 125VAC / 1A 30VDC** directly or heavier loads by connecting additional relay circuitry. If the output is used with an external relay, a diode must be connected in parallel with the load for protection against any voltage transients.

**Duration** - This parameter sets the minimum tampering period, that is, an alarm will not be triggered until this period has lapsed, even if the tampering conditions are otherwise met. This could help to prevent false alarms for known conditions that affect the image.

**Caution!** Connecting AC to the inputs/outputs will damage the unit.

## 9.2 Event > Motion

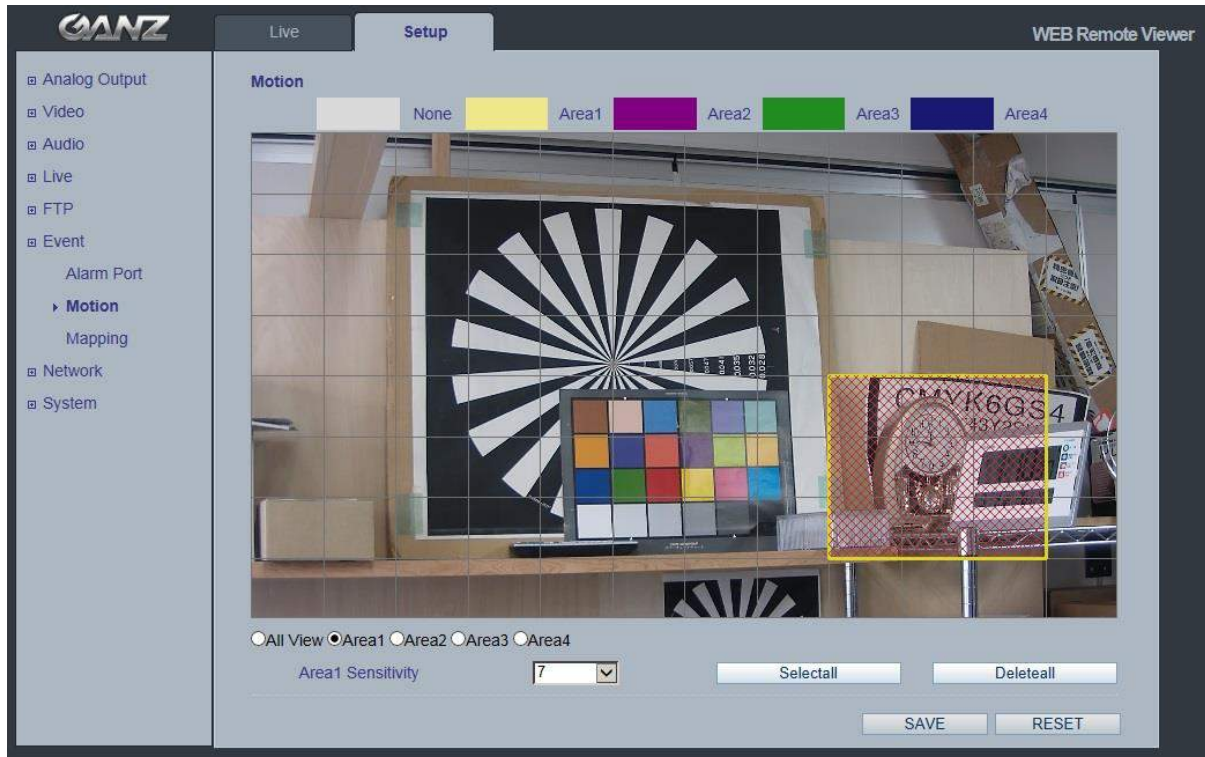

### Motion Detection

Motion detection is used to generate an alarm whenever movement either occurs or stops in the video image. A maximum of 4 windows could be configured.

Area Sensitivity : 1(low) ~ 10(High) – The higher the number is, the higher the sensitivity level becomes.

### Configuring Motion Detection

1. Click **Motion Detection** in the **Event Config** menu.
2. Select an Area from **Area1** to **4** to activate a Motion setup window.
3. Click the Motion window, and select an area that you want to specify the Motion area.
4. Select sensitivity value (1 ~ 10) in the drop-down list.  
Any detected motion within an active window is then indicated by red shade onto the **Activity** window.
5. Click **Save**.

**Note:** Using the motion detection feature may decrease the camera's overall performance.



## 9.3 Event > Mapping

The screenshot shows the GANZ WEB Remote Viewer interface. The top navigation bar includes 'Live' and 'Setup' tabs, with 'Setup' selected. The sidebar on the left lists various system settings: Analog Output, Video, Audio, Live, FTP, Event, Alarm Port, Motion, Mapping (highlighted), Network, and System. The main content area is titled 'Event Mapping' and features a table with the following data:

Alarm Sensor	Alarm Out	E-mail
Alarm In	<input type="checkbox"/>	<input type="checkbox"/>
Motion	<input type="checkbox"/>	<input type="checkbox"/>

Below the table are 'SAVE' and 'RESET' buttons. At the bottom of the main area, there are links: 'Go to', 'Setup E-mail', 'Alarm Port', and 'Motion'.

It is possible to define conditions that would cause the camera to respond with certain actions. A triggered event happens as a result of a trigger, which could be motion detection or an external alarm input.

For example,

Alarm out events could be triggered by video motion detection or alarm in.  
E-mail could be sent by video motion detection or alarm in.

# 10. Network

## 10.1 Network > IP Setup

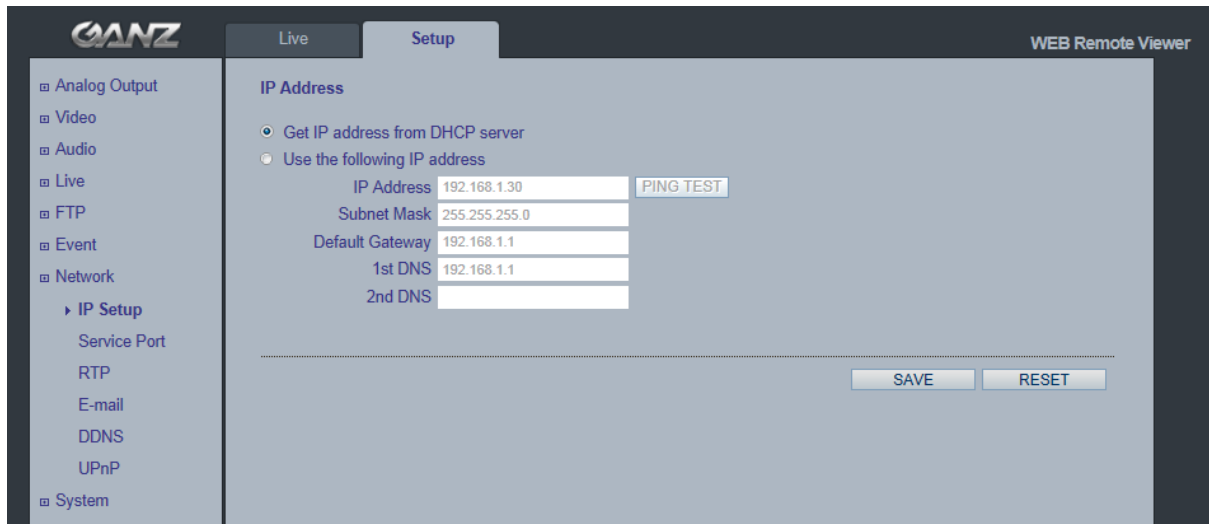

### Network Settings

Click the **Setup > Network > IP Setup** to see the current network settings.

### IP Address Configuration -

The GANZ PixelPro supports both IP version 4 and IP version 6 (**IPv6 will be supported in V3.00**). Both versions may be enabled simultaneously, and at least one version should be always enabled.

When using IPv4, the IP address could be set automatically via DHCP, or a static IP address could be set manually. If IPv6 is enabled, your camera receives an IP address according to the configuration in the network router.

There are also options for setting up notification of changes in the IP address, and for using the Internet Dynamic DNS Service.

**Notes:** • *To receive notification whenever the camera's IP address changes (via e.g. DHCP), configure the options for notification of IP address change. See Services below.* • *If your DHCP server could update a DNS server, you could access the GANZ PixelPro by a host name which is always the same, regardless of the IP address.*

### DNS Configuration

DNS (Domain Name Service) provides the translation of host names to IP addresses on your network.

#### •1st DNS server

Enter the IP address of the primary DNS server for your network.

#### •2nd DNS server

Enter the IP of the Secondary DNS, which is used if the Primary DNS server is unavailable.

## How to assign IP address

Default setting is set to “DHCP” and “UPnP” function is set to ON. If your network has DHCP server and UPnP function is enabled on your PC, you can find the network camera in “My network”.

If DHCP server is not available in your network, please assign IP address as following process.

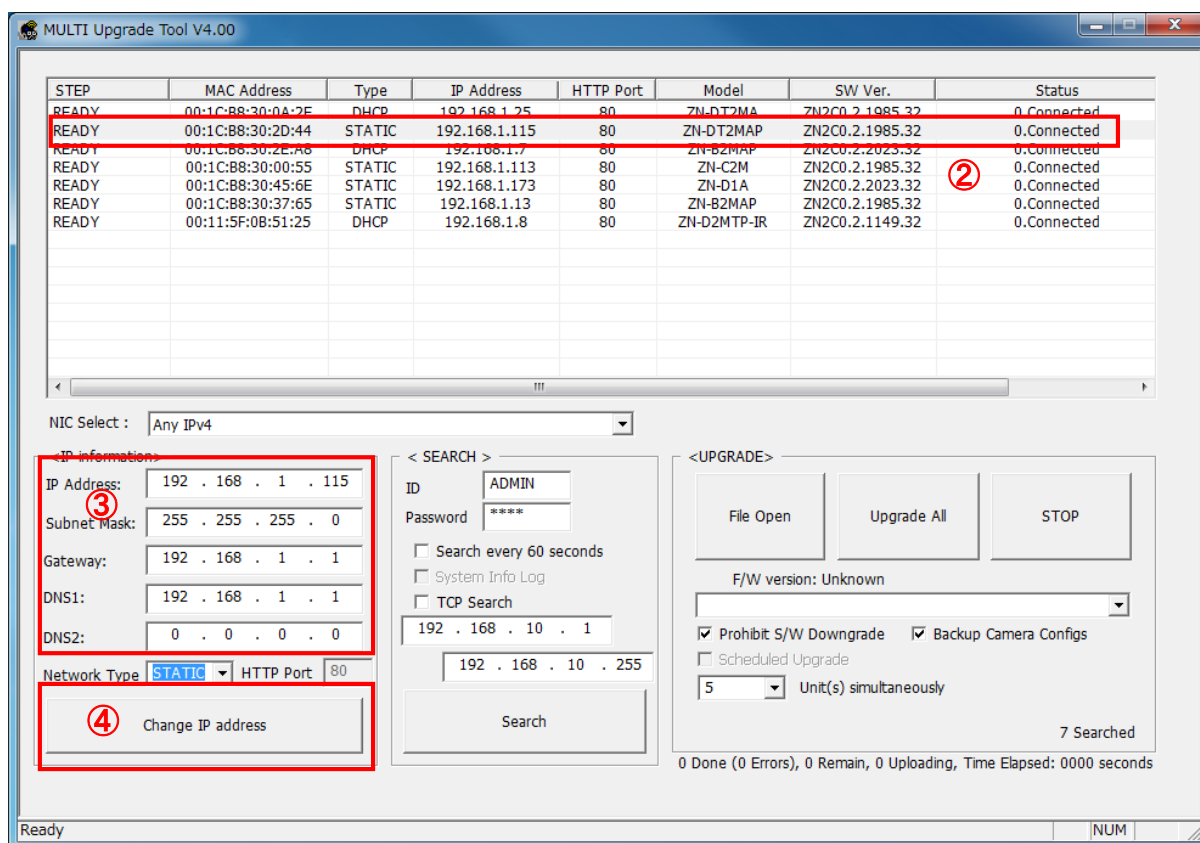

- 1) Execute “MultiUpgradeTool.exe”, it will search the camera on the network.
- 2) After the camera is listed in camera list, select the camera.
- 3) Type in the all network information.
- 4) Click “Change IP address” button to set network settings to the camera.

When you double-click the camera within the list, the default web browser (Internet Explorer or compatible equivalent) will open and automatically connect to the camera.

## 10.2 Network > Service Port

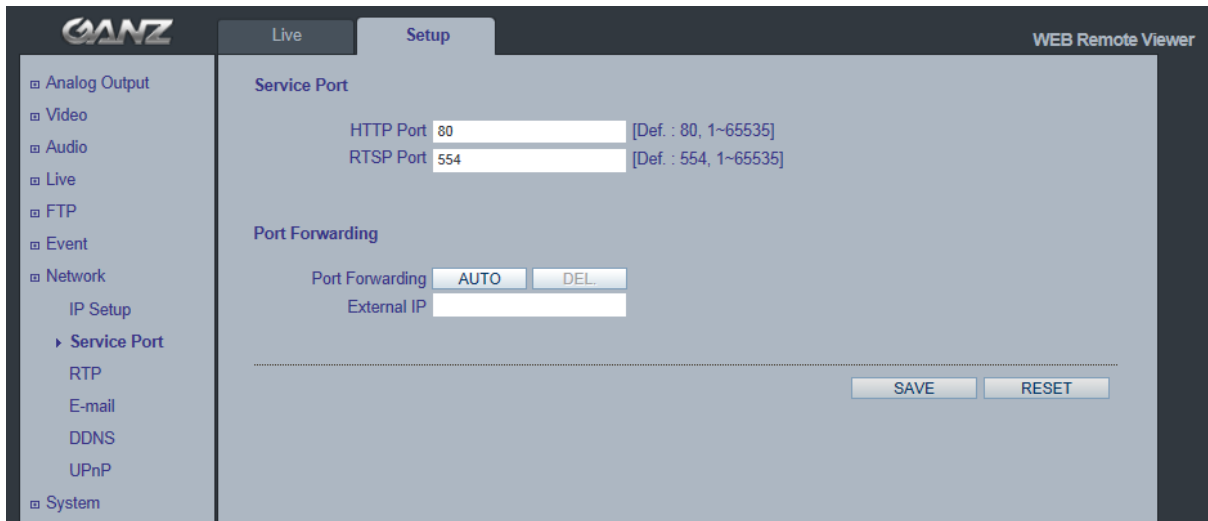

### Service Port

**HTTP port-** The default HTTP port number (**80**) could be changed to any port within the range 1-65535. This is useful for simple port mapping.

**RTSP port-** The RTSP protocol allows a connecting client to start an H.264 stream. Enter the RTSP port number to use. The default setting is **554**.

*NOTE: After changing the default port numbers, the user can use the "MultiUpgradeTool.exe" to search and connect automatically.*

## 10.3 Network > RTP

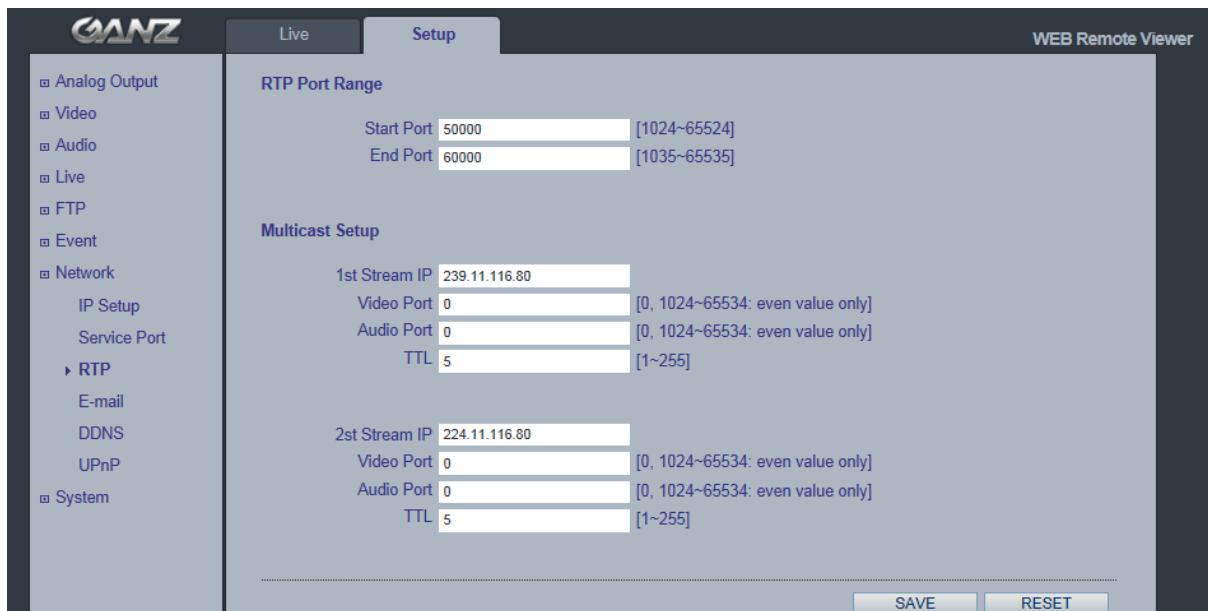

### RTP port range , Multicast Setup

These settings are the IP address, port number, and Time-To-Live value to use for the video stream(s) in multicast H.264 format.

Only certain IP addresses and port numbers should be used for multicast streams.

## 10.4 Network > E-mail

The screenshot shows the 'E-mail Setup' page in the GANZ WEB Remote Viewer. The left sidebar contains a navigation menu with options: Analog Output, Video, Audio, Live, SD Card, FTP, Event, Network (expanded), IP Setup, Service Port, RTP, E-mail (selected), DDNS, UPnP, and System. The main content area is titled 'E-mail Setup' and includes the following fields:

- Notification: ON (dropdown)
- Frequency: 5 Min (dropdown)
- Server: smtp.ipcam.com (text input)
- Port: 25 (text input)
- Security: ON (dropdown)
- User: user@ipcam.com (text input)
- Password: \*\*\*\*\* (password field)
- From: user@ipcam.com (text input)

At the bottom right, there are 'SAVE' and 'RESET' buttons. Below the form, there are links: 'Go to: Setup To enable Address' and 'Setup Event Mapping'.

You must turn Notification to 'On' and then enter the host names or addresses for your mail servers in the fields provided, to enable the sending of event and error email messages from the camera to predefined addresses via SMTP.

Note1)

Frequency : Mail server may register the sender to SPAM list when frequency is set to "1 Min". It may be better to set "5 Min" for safe side.

Note2)

From : Specify the name who sent e-mail notification. It may be better to use e-mail format like as [aaa@bbb.com](mailto:aaa@bbb.com). Some e-mail server will refuses it.

## 10.5 Network > DDNS

The screenshot shows the 'DDNS Setup' page in the GANZ WEB Remote Viewer. The left sidebar is the same as in the previous screenshot, with 'DDNS' selected. The main content area is titled 'DDNS Setup' and includes the following fields:

- DDNS: ON (dropdown)
- User Set URL: http:// [ ] .dvrlink.net (text input)

At the bottom right, there are 'SAVE' and 'RESET' buttons.

How to setup the DDNS:

1) DDNS set to ON.

“*mac address.dvrlink.net*” is registered to the DDNS server.

User can connect to the camera with: “*http://mac address.dvrlink.net*”.

2) DDNS set to ON and user inputs “*user-defined name*”.

“*mac address.dvrlink.net*” and “*user-defined name.dvrlink.net*” are both registered together.

User can connect to the camera using either:

“*http://mac address.dvrlink.net*” or “*http://user-defined name.dvrlink.net*”.

If “*user-defined name*” is already registered, an error message is shown, try a different name.

## 10.5 Network > UPnP

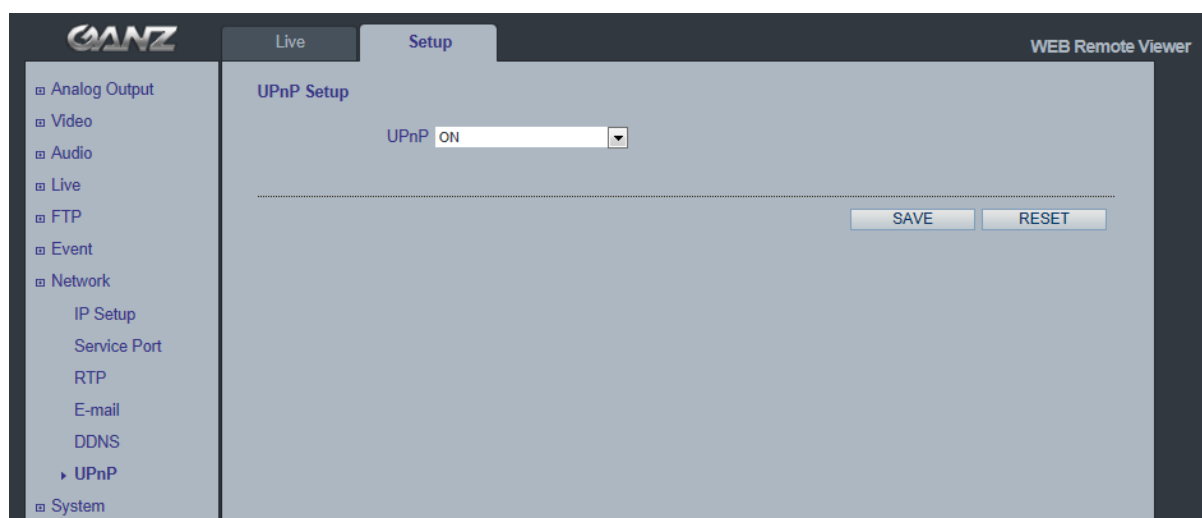

Universal Plug & Play (UPnP) allows you to find the IP camera automatically on your network.

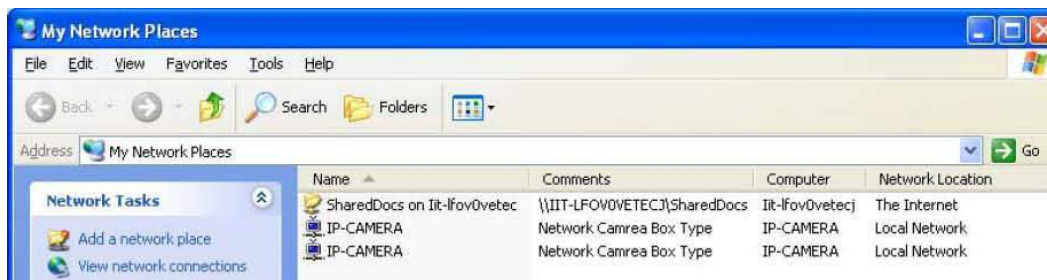

In order to be able to detect the camera automatically, you must enable the UPnP function on both the camera and on your PC.

Camera : Set UPnP to “ON”

PC : Open “Control Panel” >”Network Connection”  
Select “Advanced” >”Optional Networking Components...”

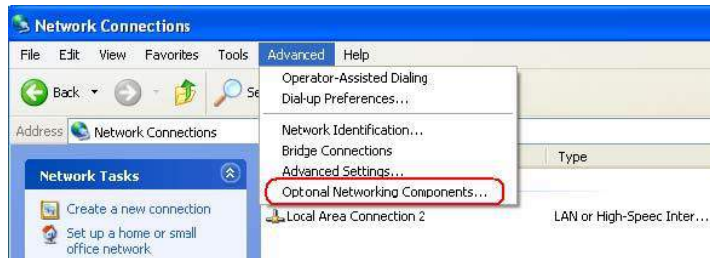

Select “Network Services” and click “Details”. Then select “UPnP user Interface”

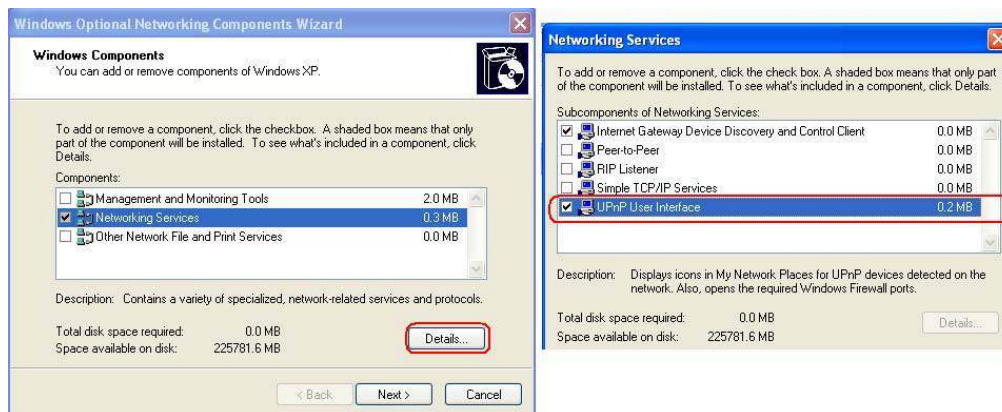

## 11. System

### 11.1 System > User

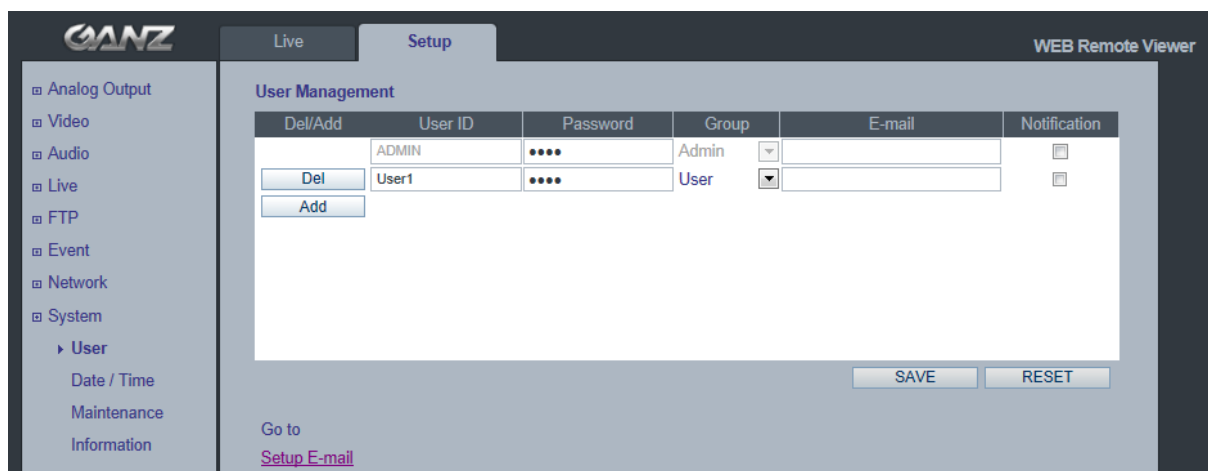

Access the camera and the **Configure Root Password** dialog appears.

Enter the User name: **ADMIN** and password is 1234.

To changed password or add a user click SETUP > SYSTEM > USER. Fill the User ID, Password and E-mail server. Select Group. Then press ADD button and click SAVE.

**Note:** The default administrator user name **ADMIN** is permanent and could not be deleted or altered.

## 11.2 System > Date & Time

The screenshot shows the 'Date / Time Setup' page in the GANZ camera web interface. The interface has a dark header with the GANZ logo and 'WEB Remote Viewer' text. A sidebar on the left contains a menu with options like Analog Output, Video, Audio, Live, FTP, Event, Network, System, User, Date / Time, Maintenance, and Information. The main content area is titled 'Date / Time Setup' and contains the following fields and controls:

- Current Server Time:** 2013/02/19 15:08:48
- Date format:** YYYY/MM/DD (dropdown)
- Time format:** 24 Hour (dropdown)
- Synchronize with NTP server:** Radio button (selected)
- NTP server:** POOL.NTP.ORG (text input)
- User set manually:** Radio button (unselected)
- Local Time:** 2013 / 02 / 19 15 : 08 : 40 (text input) with a **PC Sync / SAVE** button next to it.
- Time Zone:** GMT-05:00 America/EST (dropdown)
- D.S.T:** OFF (dropdown)

At the bottom right of the main content area, there are **SAVE** and **RESET** buttons.

**Date & Time Format** - specify the formats for the date and time (12h or 24h) displayed in the Live View video streams. Use the predefined formats or use your own custom date and time formats.

**Network Time Server** - the camera will obtain the time from an NTP server every 60 minutes. Specify the **NTP server's** IP address or host name.

**Time zone setup** – Select your time zone from the drop-down list.

**D.S.T (Daylight Saving Time)** - ON/OFF



## 11.3 System > Maintenance

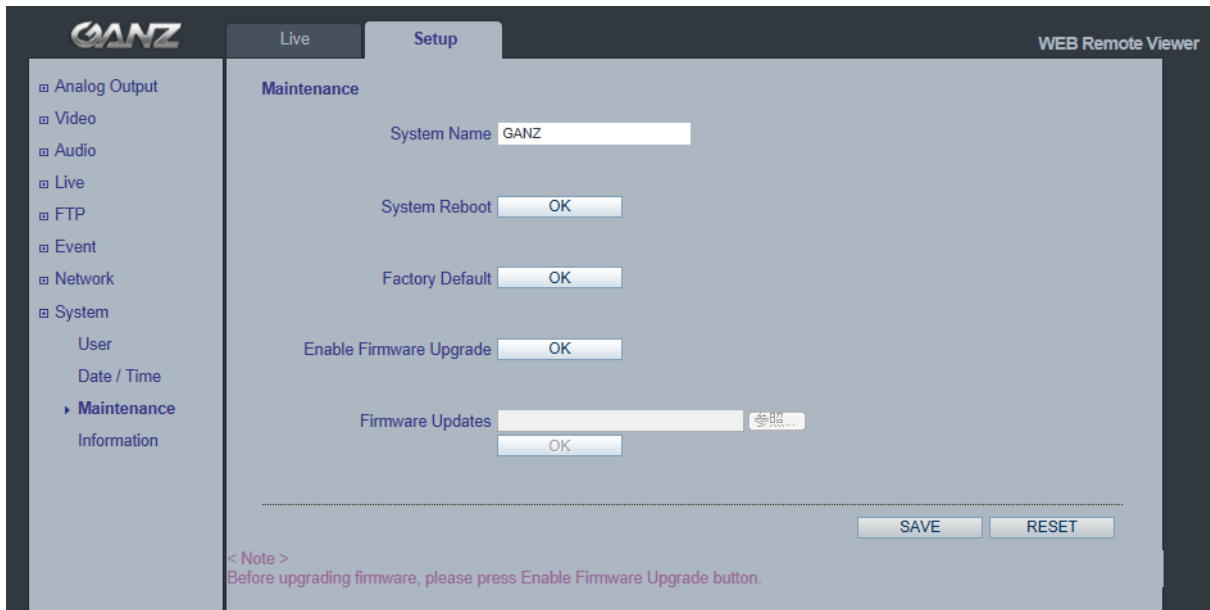

### System Name

Choose a system name to identify the camera when using e-mail notifications.

### System Reboot

Reboot the camera.

### Factory Default

To reset the camera back to the original factory default settings.

### Enable Firmware Upgrade / Firmware Updates

To upgrade Firmware of the camera, follow the instruction below.

*NOTE: Preconfigured and customized settings should be saved before the firmware is upgraded.*

- 1) Enable Firmware Upgrade mode with clicking “OK” of Enable Firmware Upgrade menu.
- 2) The camera automatically switch to Firmware Upgrade mode.

### Changing to Firmware Update Mode...

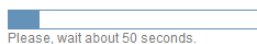

Please, wait about 50 seconds.

- 3) When Firmware upgrade menu is displayed, browse to the desired firmware file on your computer. Click OK.

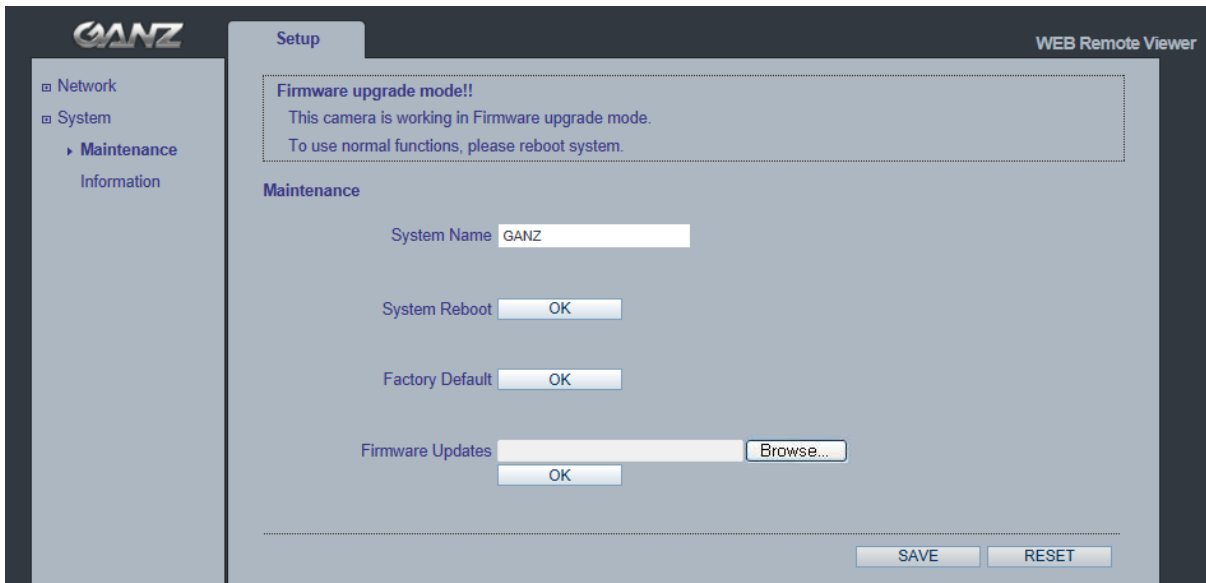

**NOTE:** Do not disconnect power to the unit during the upgrade. The unit will restart automatically after the upgrade has completed. (1~5 minutes)

## System Reset (Factory Default Reset)

There are two ways to reset the camera back to factory default. holding down about 10-20 sec the reset button on the Network cable

*Using the web browser:*

1. Go to SETUP > System > Maintenance.
2. Click Factory Default Button and wait 1 minute for camera to reboot.

*Using the Reset Button:*

1. Holding down 15-20 sec the reset button on the Network cable.
2. Release your finger on the reset button, waiting about 1 minute for camera reboot

**NOTE:** The unit will now have the default IP address from a DHCP server. Use the "MultiUpgradeTool.exe" to discover and connect to the camera.

## 11.4 System > Information

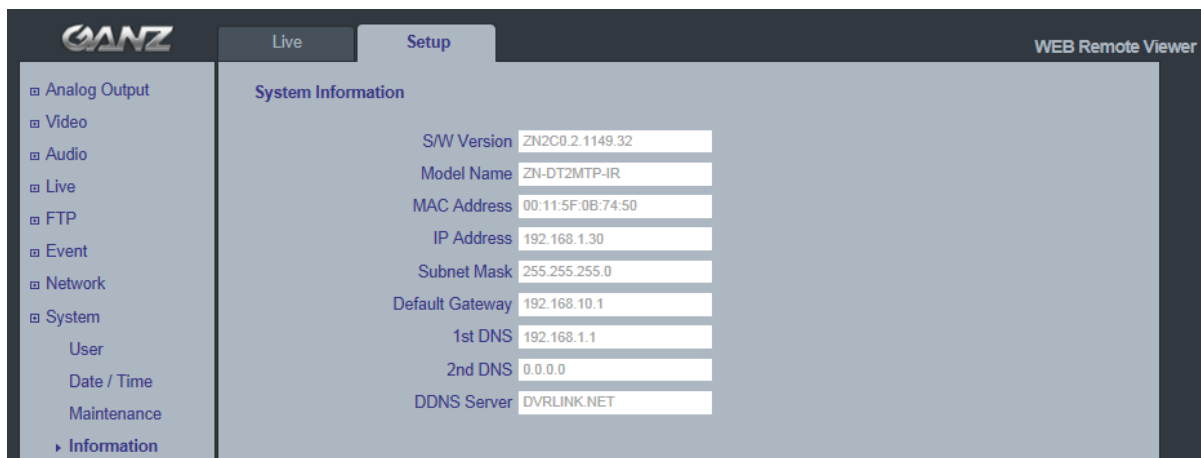

The screenshot displays the WEB Remote Viewer interface for a ZN2C0.2.1149.32 camera. The interface is divided into a left sidebar menu and a main content area. The sidebar menu includes options like Analog Output, Video, Audio, Live, FTP, Event, Network, System, User, Date / Time, Maintenance, and Information. The main content area shows the 'System Information' page under the 'Setup' tab. The system information is presented as a table with the following details:

Parameter	Value
S/W Version	ZN2C0.2.1149.32
Model Name	ZN-DT2MTP-IR
MAC Address	00:11:5F:0B:74:50
IP Address	192.168.1.30
Subnet Mask	255.255.255.0
Default Gateway	192.168.10.1
1st DNS	192.168.1.1
2nd DNS	0.0.0.0
DDNS Server	DVRLINK.NET

### System Information

You can confirm the system information if the camera here.

## 12. Dimension (mm)

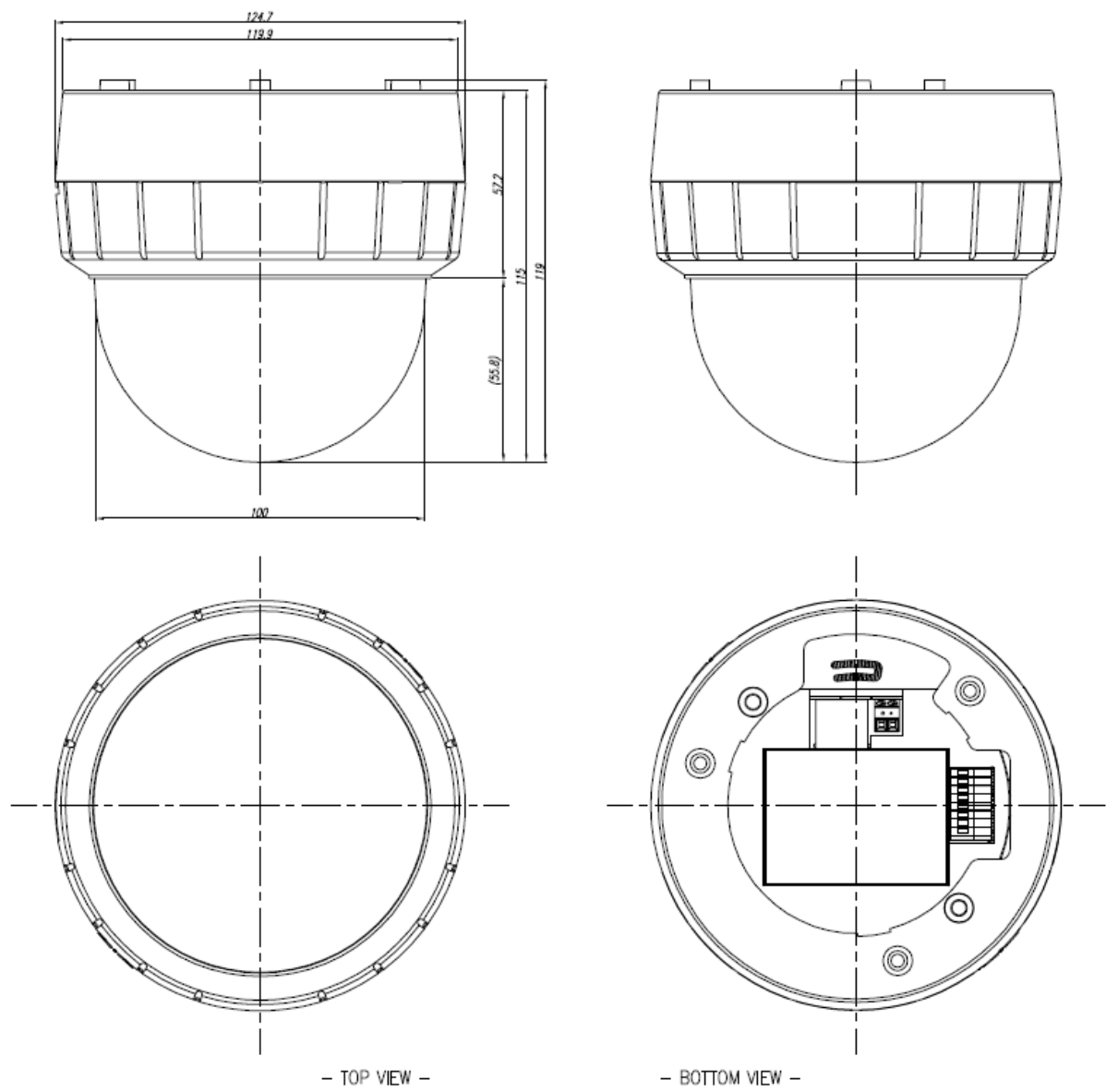

## 13. Specification

<b>Product Features</b>		H.264 / MJPEG Network Camera
		Dual Stream
		Motion Triggered Alarm/ External Alarm In
		Multi Language GUI support
		ONVIF Compliant
		Triple Power. 12VDC, 24VAC, PoE(802.3af)
		SONY CMOS Sensor IMX122
		On The Fly supported @ GOP/Bitrate/FPS setting
		2D DNR. (Depends on CODEC configuration) - 3D TBD
		DPC(Defective Pixel Correction) on the fly
		18 IR LEDs (IR model)
		Motorized Zoom, Focus and P-iris
		True Day & Night
		Analog Hybrid Output(Installation Only)
		Privacy Masking
	<b>CAMERA</b>	<b>Image Sensor</b>
<b>Max. Resolution</b>		1920 x 1080; (2MTP), 1280 x 1024; (1MTP)
<b>Effective Pixels</b>		1984(H) x 1225(V)
<b>Effective Image Size</b>		5.56mm(H) x 3.43mm(V), 6.53mm(Diagonal)
<b>White Balance</b>		ATW / MANUAL(PRESET)
<b>Electronic Zoom</b>		2 ~ 10x(Client Software)
<b>AGC</b>		Yes
<b>BLC</b>		Yes
<b>Iris</b>		Motorized Iris / MANUAL / AES
<b>Shutter Speed</b>		1/4, 1/10, 1/12.5, 1/15, 1/20, 1/25, 1/30, 1/50, 1/60, 1/100, 1/120, 1/240, 1/480, 1/960, 1/1024, 1/2000s
<b>Slow Shutter</b>		2x, 4x, 8x
<b>Lens</b>		Motorized Zoom and Focus lens f=3~9mm, F1.2~2.1
<b>Angle of View</b>		Horizontal ; f=3mm(Wide) 104.2° , f=9mm(Tele) 35.5°
<b>Day &amp; Night</b>		Removable IR Cut Filter
<b>S/N ratio</b>		48.8 dB or more
<b>Min. illumination</b>	0 lux with IR LED ON ;IR model 0.16 lux(F1.2, 50IRE) ;w/o IR model	
<b>ANALOG (Installation Only)</b>	<b>Video Signal</b>	NTSC / PAL selectable
	<b>Monitor Output</b>	Composite Output(BNC), 75 ohm 1Vpp
	<b>Scanning Frequency</b>	NTSC: (H) 15.734 kHz, (V) 59.94 Hz PAL: (H) 15.625 kHz, (V) 50 Hz
<b>AUDIO</b>	<b>In/Out</b>	Line in, Line out External Amplifier is needed
	<b>CODEC</b>	G.711 / 8K sampling

<b>NETWORK</b>	<b>Network</b>	10BASE-T, 100BASE-TX, RJ45
	<b>Image Compression</b>	H.264
	<b>Resolution</b>	MJPEG : Image quality: 100 Steps(Q value)
		1920 x 1080(Full HD; 2MTP), 1280 x 1024(SXGA),
		1024x768(XGA), 1280 x 720(720p)
		640 x 480(VGA), 640 x 360(HVGAW), 320 x 240(QVGA)
		704x480/576(4CIF), 352x240/288(CIF)
	<b>Protocol</b>	IPv4, HTTP, SMTP, UPnP, DNS, RTSP, DDNS, RTP, TCP, UDP, RTCP, DHCP, ARP, IGMP, ICMP, NTP
	<b>Frame Rate</b>	1 fps ~ 25 fps / 1 fps ~ 30 fps
	<b>Web Browser</b>	Internet Explorer 7.0 or above
		Firefox
		Chrome
	<b>Security</b>	PDA / Smart phone Password Protection
	<b>SDK(API)</b>	HTTP based API ONVIF Profile S
	<b>VMD</b>	User set 4 ROI(Region Of Interest)
10 Step Sensitivity		
<b>Alarm Trigger</b>	VMD, External Alarm Input	
<b>Alarm Event</b>	E-mail notification(Snapshot), FTP transfer(Snapshot), Video streaming with alarm status	
<b>POWER</b>	<b>Power Consumption</b>	500mA @ DC12V, 6.0W 420mA @ AC24V, 6.2W 120mA @ DC48V(PoE), 5.8W
	<b>Power Consumption (IR model)</b>	680mA @ DC12V, 8.2W 510mA @ AC24V, 7.5W 150mA @ DC48V(PoE), 7.2W
	<b>Heater</b>	-
<b>OTHER SPECIFICATIONS</b>	<b>Micro SD Card</b>	-
	<b>External I/O Terminals</b>	Alarm In x1: NO/NC Dry contact Alarm Out x1: Relay output
		Audio In x1, Audio Out x1
	<b>IR Number</b>	18 IR LEDs (IR model)
	<b>FAN Number</b>	-
	<b>Ambient Temperature (not cold start)</b>	-5°C ~ +45°C(23°F~113°F)
	<b>Ambient Humidity</b>	less than 90%, Non-condensing
	<b>Materials</b>	Poly Carbonate 2(PC2)
	<b>Weight</b>	0.4kg
<b>Dimensions(W x H x D)</b>	124.7(D) x 119(H) mm	



## English

### Disposal of your old appliance

---

1. When this crossed-out wheeled bin symbol is attached to a product it means the product is covered by the European Directive 2002/96/EC.
2. All electrical and electronic products should be disposed of separately from the municipal waste stream via designated collection facilities appointed by the government or the local authorities.
3. The correct disposal of your old appliance will help prevent potential negative consequences for the environment and human health.
4. For more detailed information about disposal of your old appliance, please contact your city office, waste disposal service or the shop where you purchased the product.

## Français/French

### Élimination de votre ancien appareil

---

1. Ce symbole, représentant une poubelle sur roulettes barrée d'une croix, signifie que le produit est couvert par la directive européenne 2002/96/EC.
2. Tous les produits électriques et électroniques doivent être éliminés séparément de la chaîne de collecte municipale des ordures, par l'intermédiaire des installations de collecte prescrites et désignées par le gouvernement ou les autorités locales.
3. Une élimination conforme aux instructions aidera à réduire les conséquences négatives et risques éventuels pour l'environnement et la santé humaine.
4. Pour plus d'informations concernant l'élimination de votre ancien appareil, veuillez contacter votre mairie, le service des ordures ménagères ou encore le magasin où vous avez acheté ce produit.

## Deutsch/German

### Entsorgung von Altgeräten

---

1. Wenn dieses Symbol eines durchgestrichenen Abfalleimers auf einem Produkt angebracht ist, unterliegt dieses Produkt der europäischen Richtlinie 2002/96/EC.
2. Alle Elektro- und Elektronik-Altgeräte müssen getrennt vom Hausmüll über die dafür staatlich vorgesehenen Stellen entsorgt werden.
3. Mit der ordnungsgemäßen Entsorgung des alten Geräts vermeiden Sie Umweltschäden und eine Gefährdung der persönlichen Gesundheit.
4. Weitere Informationen zur Entsorgung des alten Geräts erhalten Sie bei der Stadtverwaltung, beim Entsorgungsamt oder in dem Geschäft, wo Sie das Produkt erworben haben.



## Italiano/Italian

### RAEE: SMALTIMENTO DELLE VOSTRE VECCHIE APPARECCHIATURE

---

1. Quando il simbolo del "Cassonetto Barrato" è apposto su un prodotto, significa che lo stesso può ricadere nei termini previsti dalla Direttiva Europea nr. 2002/96/EC in funzione dell'attuazione definita dalla Legislazione dei singoli stati membri dell'Unione Europea.
2. Tutti i prodotti elettrici ed elettronici dovrebbero essere smaltiti separatamente dai rifiuti municipali, tramite appositi contenitori, approvati dall'Amministrazione Comunale o dalle Autorità Locali.
3. Il corretto smaltimento delle vostre vecchie apparecchiature, contribuirà a prevenire possibili conseguenze di impatto negativo sull'ambiente e per la salute dell'uomo.
4. Per maggiori informazioni circa lo smaltimento delle vostre vecchie apparecchiature, siete pregati di contattare l'ufficio municipale della vostra città, il servizio di smaltimento rifiuti o il punto vendita nel quale avete acquistato il prodotto.

## Polski/Polish

### Utylizacja starych urządzeń

---

1. Kiedy do produktu dołączony jest niniejszy przekreślony symbol kołowego pojemnika na śmieci, oznacza to, że produkt jest objęty europejską dyrektywą 2002/96/EC.
2. Wszystkie elektryczne i elektroniczne produkty powinny być utylizowane niezależnie od odpadów miejskich, z wykorzystaniem przeznaczonych do tego miejsc składowania wskazanych przez rząd lub miejscowe władze.
3. Właściwy sposób utylizacji starego urządzenia pomoże zapobiec potencjalnie negatywnemu wpływowi na zdrowie i środowisko.
4. Aby uzyskać więcej informacji o sposobach utylizacji starych urządzeń, należy skontaktować się z władzami lokalnymi, przedsiębiorstwem zajmującym się utylizacją odpadów lub sklepem, w którym produkt został kupiony.

## Português/Portuguese

### Eliminação do seu antigo aparelho

---

1. Quando este símbolo de latão cruzado estiver afixado a um produto, significa que o produto é abrangido pela Directiva Europeia 2002/96/EC.
2. Todos os produtos eléctricos e electrónicos devem ser eliminados separadamente da coleta de lixo municipal através de pontos de recolha designados, facilitados pelo governo ou autoridades locais.
3. A eliminação correcta do seu aparelho antigo ajuda a evitar potenciais consequências negativas para o ambiente e para a saúde humana.
4. Para obter informações mais detalhadas acerca da eliminação do seu aparelho antigo, contacte as autoridades locais, um serviço de eliminação de resíduos ou a loja onde comprou o produto.

## Español/Spanish

### Cómo deshacerse de aparatos eléctricos y electrónicos viejos

---

1. Si en un producto aparece el símbolo de un contenedor de basura tachado, significa que éste se acoge a la Directiva 2002/96/EC.
2. Todos los aparatos eléctricos o electrónicos se deben desechar de forma distinta del servicio municipal de recogida de basura, a través de puntos de recogida designados por el gobierno o las autoridades locales.
3. La correcta recogida y tratamiento de los dispositivos inservibles contribuye a evitar riesgos potenciales para el medio ambiente y la salud pública.
4. Para obtener más información sobre cómo deshacerse de sus aparatos eléctricos y electrónicos viejos, póngase en contacto con su ayuntamiento, el servicio de recogida de basuras o el establecimiento donde adquirió el producto.



## America

**CBC (AMERICA) CORP.**  
**New York**  
55 Mall Drive,  
Commack, NY 11725, U.S.A.  
<http://www.computarganz.com>

CBC (AMERICA) CORP.  
Los Angeles Division  
21241 South Western Avenue, Suite 160  
Torrance, CA 90501, U.S.A.  
<http://www.computarganz.com>

## Europe

CBC EUROPE GmbH  
**Düsseldorf**  
Hansaallee 191  
D-40549 Düsseldorf, GERMANY  
<http://www.cbc-europe.com>

CBC EUROPE GmbH UK Branch  
**London**  
7/8, Garrick Industrial Centre,  
Irving Way, London NW9 6AQ, U.K.  
<http://www.cbceurope.com>

CBC (EUROPE) S.r.l.  
**Milan**  
Via E. Majorana, 2  
20834-Nova Milanese(MB), ITALY  
<http://www.cbceurope.it/cctv>

CBC (Poland) Sp.z o.o.  
Warszawa  
Ul.Krasynskiego 41A  
01-755 Warszawa  
<http://www.cbcpoland.pl>

**CBC Co., Ltd. MOSCOW REP OFFICE**  
**Moscow**  
Office 503B, Entrance#3, Building 1,  
World Trade Center, 12 Krasnopresnenskaya nab., Moscow,  
123610, RUSSIA  
<http://www.cbc.ru>

## China

**CBC(Beijing) Trading CO.,LTD.**  
**Beijing**  
Room B905-A, Tian Yuan Gang Center,  
No.C2 Dong San Huan Bei-Lu,  
Chaoyang District,  
Beijing, CHINA  
<http://www.cbc-china.cn/>

CBC (SHANGHAI) Trading CO., Ltd.  
Shanghai  
Room 1801, GIFC, No.1438 HongQiao Road, Changning  
District, Shanghai, CHINA  
<http://www.cbc-china.cn/>

CBC (GUANGZHOU) Trading CO., Ltd.  
Guangzhou  
Room 1207, CITIC Plaza, No.233 Tian He North  
Road, Guangzhou City, Guangdong Province,  
CHINA  
<http://www.cbc-china.cn/>

**CBC (H.K.) CO., LTD.**  
**Hong Kong**  
Unit 2101, 21/F., Tower 6,  
China Hong Kong City, 33 Canton Road,  
Tsim Sha Tsui, Kowloon, Hong Kong, CHINA  
<http://www.cbc-china.cn/>

## Asia

**CBC. S PTE LTD.**  
**Singapore**  
15 Jalan Kilang Barat, #04-03  
Frontech Centre, SINGAPORE 159357  
<http://www.cbcsingapore.com/>

**CBC (Thailand) Co.,Ltd.**  
**Bangkok**  
23rd Floor, ITF Tower 2, 140/53-55  
Silom Road, Suriyawongse,  
Bangrak, Bangkok 10500  
THAILAND  
<http://www.cbcthailand.com/>

CBC Corporation (India) Private Limited  
Mumbai  
2F B Wing, Marwah Centre,  
Krishanlal Marwah Marg,  
Andheri East, Mumbai 400 072, INDIA

PT. CBC PRIMA  
Jakarta  
MidPlaza II Building, 12th Floor,  
Jl.Jend.Sudirman Kav. 10-11  
Jakarta Pusat, 10220, INDONESIA

T-CBC (TAIWAN) CO., Ltd.  
Taiwan  
Room D, 10th Floor, No.365 Fushing N. Rd.,  
Taipei, 10543, TAIWAN, R. O. C.  
<http://www.t-cbc.com.tw/>



[www.cbc.co.jp](http://www.cbc.co.jp)  
[www.ganz-global.com](http://www.ganz-global.com)